

PCA Patient Controlled Analgesia Delivery Mode

CADD  Prizm<sup>®</sup> VIP

Model 6100 and 6101

Ambulatory

Infusion

Pumps





**Deltec**



SMITHS INDUSTRIES  
Medical Systems

# Table of Contents

Introduction .....	1
Warnings .....	2
Cautions .....	4
CADD-Prizm® Pump (Diagram) .....	6
Description of the Keys .....	7
Installing a New Battery .....	8
The Main Screen .....	10
The HELP Key  .....	11
Starting the Pump .....	12
Stopping the Pump .....	13
Getting a Dose  .....	14
Removing a Cassette .....	15
Attaching a Cassette .....	16
Resetting the Reservoir Volume .....	19
Priming the Tubing and Starting the Pump .....	20
Inserting the Tubing into the Air Detector .....	22
Remote Dose Cord .....	23
What if I drop or hit the pump? .....	24
Alarms and Messages .....	25

## Introduction

Your doctor has recommended that you use the **CADD-Prizm® pump** as part of your treatment.

The CADD-Prizm® pump can be carried with you and is designed to deliver medication into your body. PCA stands for patient controlled analgesia. Your physician will prescribe your medication specifically for you. Your prescription is programmed into your pump by your clinician according to your physician's specific orders. This pump can be reprogrammed as your medication needs change.

The pump can be programmed to deliver medication at a constant rate and/or to allow delivery of a bolus dose at a specified time interval. The pump stores programmed information and historical information that your clinician needs for your specific therapy.

Your clinician will instruct you on the proper use of this pump. This guide is intended to supplement those instructions. Perform only those procedures for which you have received training.

The following is a list of warnings and cautions that you should read before operating the pump. It is important that you understand and follow these warnings and cautions.

**Failure to properly follow warnings, cautions, and instructions could result in damage to the pump or death or serious injury.**

## Warnings

- If the pump is used to deliver life-sustaining medication, an additional pump must be available.
- Use of a syringe with the CADD® Administration Set may result in UNDER-DELIVERY of medication. Syringe function can be adversely affected by variations in plunger dimension and lubricity, which can result in greater force required to move the syringe plunger. A syringe plunger will lose lubrication as it ages and, as a result, the amount of under-delivery will increase and could, on occasion, be significant.

You must regularly compare the volume remaining in the syringe to the pump's displayed values such as Reservoir Volume or Given to determine if under-delivery is occurring and, if necessary, contact your clinician.

- Pressing the  key to turn the display back on may deliver an inadvertent dose, resulting in over-delivery of medication.
- Do not use rechargeable NiCad or nickel metal hydride (NiMH) batteries. Do not use carbon zinc ("heavy duty") batteries. They do not provide sufficient power for the pump to operate properly.
- Always have new batteries available for replacement. If power is lost, non-delivery of drug will occur.
- There is no pump alarm to alert you that the battery has

not been properly installed or has become dislodged. An improperly installed or dislodged battery could result in loss of power and non-delivery of drug.

- If the pump is dropped or hit, the battery door may become broken or damaged. Do not use the pump if the battery door is damaged because the battery will not be properly secured; this may result in loss of power or non-delivery of drug.
- Prior to starting infusion, inspect the fluid path for kinks, a closed clamp, or other upstream obstructions, and remove all air to prevent air embolism.
- Do not place the Remote Dose Cord where the button might accidentally be pushed. Accidentally pushing the button may deliver a Dose, causing over-delivery of medication.
- Close the tubing clamp before removing the cassette from the pump to prevent unregulated gravity infusion.
- You must use a CADD® Extension Set with Anti-Siphon Valve or a CADD® Administration Set with either an integral or add on Anti-Siphon Valve to protect against delivery inaccuracies and unregulated gravity infusion that can result from an improperly attached cassette.
- For detailed instructions and warning pertaining to Medication Cassette™ Reservoirs or CADD® Administration Sets, please refer to the instructions for use supplied with those products.
- Frozen Medication must be thawed at room temperature only. Do not heat the Medication Cassette™ Reservoir in a microwave oven as this may damage the medication, the

Medication Cassette™ Reservoir, or cause leakage.

- Attach the cassette (the part of the Medication Cassette™ Reservoir or CADD® Administration Set that attaches to the pump) properly. An improperly attached or detached cassette could result in unregulated gravity infusion or a reflux of blood.
- Do not prime the fluid path with the tubing connected to your catheter. This could result in over-delivery of medication or air embolism.
- Ensure that the entire fluid path is free of all air bubbles before connecting to your catheter to prevent air embolism.
- If the pump is dropped or hit, inspect the pump for damage. Do not use a pump that is damaged or is not working properly. Contact your clinician for further instructions.

## Cautions

- Do not operate the pump at temperatures below + 2°C (36°F) or above 40°C (104°F).
- Do not store the pump at temperatures below -20°C (-4°F) or above 60°C (140°F). Do not store the pump with a Medication Cassette™ Reservoir or CADD® Administration Set attached.
- Do not expose the pump to humidity levels below 10% or above 90% relative humidity.
- Do not store the pump for prolonged periods with the battery installed.

- Do not immerse the pump in cleaning fluids or water or allow solution to soak into the pump, accumulate on the keypad, or enter the battery compartment, Data In/Out jack, accessory jack, or Air Detector Port area.
- Do not clean the pump with acetone, other plastic solvents, or abrasive cleaners.
- Do not use the pump in the presence of flammable anesthetics or explosive gasses.
- Use only Deltec accessories as using other brands may adversely affect the operation of the pump.

## CADD-Prizm® Pump (Diagram)



### Green Light

Blinks every 3 seconds when the pump is running and delivering medication.

### Amber Light

*Flashing:* pump is stopped; or an alarm exists. *Steady:* pump is inoperable, call clinician.

### Display

Shows information and messages. After a short time, the display turns itself off to save power. Press any key **except the**



 key to turn the display back on.

---









---

**WARNING:** Pressing  to turn the display back on may deliver an inadvertent dose, resulting in over-delivery of medication, which could result in death or serious injury.

---

---

## Description of the Keys

-  Starts and stops the pump and silences alarms.
-  Used by the clinician.
-  The “Help” Key — explains what you see on the display.
-  Used by the clinician.
-  Advances you from one screen to the next and silences some alarms.
-  Lets you give yourself a dose of medication, if allowed.
-  Used by the clinician.
-  Lets you answer yes to a question on the pump’s display.
-  Lets you answer no to a question on the pump’s display.

## Installing a New Battery

If **9-volt Battery Low** or **9-volt Battery Depleted** appears in the display, or if **Battery Low** appears on the main screen, you should change the battery.

Use a new 9 volt alkaline or lithium battery such as the DURACELL® Alkaline MN 1604, the EVEREADY® ENERGIZER Alkaline #522 or the ULTRALIFE® Lithium U9VL battery.

Dispose of used batteries in an environmentally safe manner, and according to any regulations which may apply.

---

---

### WARNINGS:

- Do not use rechargeable NiCad or nickel metal hydride (NiMH) batteries. Do not use carbon zinc (“heavy duty”) batteries. They do not provide sufficient power for the pump to operate properly, which could result in death or serious injury.
- Always have new batteries available for replacement. If power is lost, non-delivery of drug will occur and, depending on the drug being administered, could result in death or serious injury.
- There is no pump alarm to alert you that the battery has not been properly installed or has become dislodged. An improperly installed or dislodged battery could result in loss of power and non-delivery of drug and, depending on the drug being administered, could result in death or serious injury.
- If the pump is dropped or hit, the battery door may become broken or damaged. DO NOT USE the pump if it has been damaged because the battery will not be properly secured; this may result in loss of power, nondelivery of drug, and, depending on the type of drug being administered, death or serious injury.

## To install a new battery:

1. Stop the pump by pressing



2. When you see **Stop the pump?**, press **Y**.

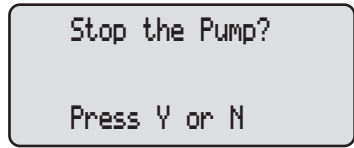

3. Press the button on the battery door and slide the battery door forward. Remove the used battery.

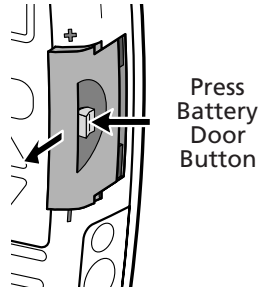

4. Match the + and - markings on the new battery with the markings on the pump. Insert the battery. The pump will beep if the battery is inserted correctly.

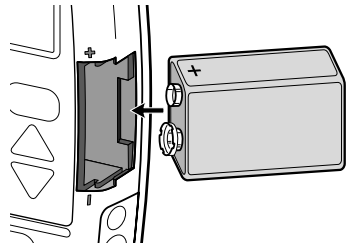

5. Replace the battery door. The pump will power up automatically.

6. Start the pump by pressing



7. When you see **Start the pump?**, press **Y**.

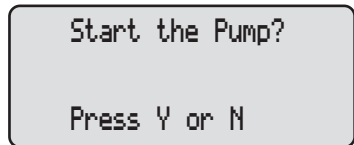

### NOTE:

- If you put the battery in backwards, the display will remain blank. Reinsert the battery, making sure to match the + and - markings.

The power up sequence will start, the pump will go through an electronic self-test, and the pump will beep at

the end of the power up sequence. All of the display indicators, the software revision level, and each parameter will appear briefly.

---

**CAUTION: Do not store the pump for prolonged periods of time with the battery installed. Battery leakage could damage the pump.**

---

### Main Screen

The following screen is what you will see on the pump's display most of the time. It is called the Main Screen and shows the following:

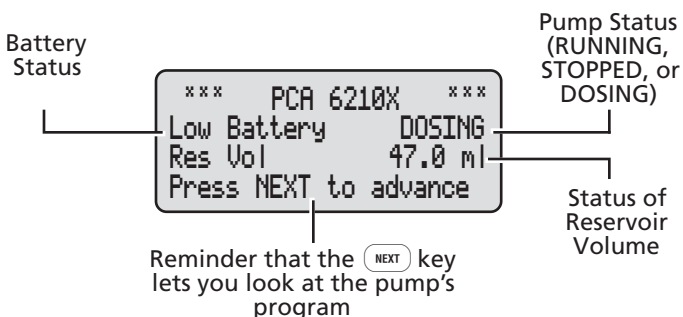

## The HELP Key

?

If you have a question about a screen, press **?** for more information. A description of the screen will appear.

For example, if you want information about the Reservoir Volume screen, you can press **?** and the following will appear:

This is the  
calculated amount of  
fluid left in the  
reservoir.

?→

The symbol (?→) in the lower right corner means there are more help screens. Press **?** again to see the next help screen.

To page through all the help screens, press **?** repeatedly. This will take you through all the help screens, then back to the original screen you had questions about.

To return to the original screen you had questions about, without going through all the help screens, press **NEXT**.

## Starting the Pump

When you start the pump, it will review the program, and then begin delivering medication. If the pump will not start, a message should appear on the display. *Refer to the Messages and Alarms section on page 25.*

---

---

**WARNING:** Prior to starting infusion, inspect the fluid path for kinks, a closed clamp, or other upstream obstructions, and remove all air bubbles to prevent air embolism. An undetected upstream occlusion may result in under- or non-delivery of drug and, depending on the drug being administered, could result in death or serious injury. Air embolism can result in death or serious injury.

---

---

1. Press .

2. When **Start the pump?** appears, press .



Start the Pump?

Press Y or N

**Starting pump...** will appear. The pump will automatically review and display the preprogrammed settings.

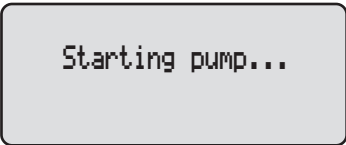

Starting pump...

**RUNNING** will appear on the main screen, the green light will blink, and fluid delivery will begin as programmed by your clinician.

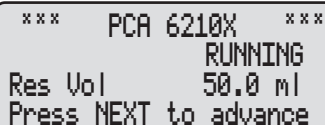

```
***  PCA 6210X  ***
                RUNNING
Res Vol      50.0 ml
Press NEXT to advance
```

## Stopping the Pump

Stopping the pump stops delivery of medication. Whenever the pump is stopped, the amber light will blink.

1. Press .

2. When **Stop the Pump?** appears, press .

**STOPPED** will appear on the main screen, and the amber light will blink.

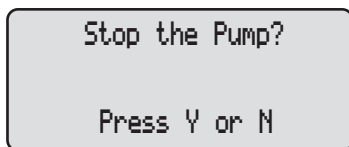

Stop the Pump?  
Press Y or N

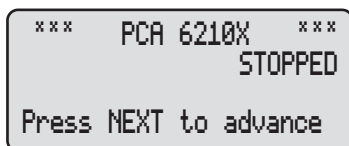

\*\*\* PCA 6210X \*\*\*  
STOPPED  
Press NEXT to advance

## Getting a Dose

Your clinician may program your pump so that you can give yourself extra doses of pain medication. Your clinician will explain when and how you should give yourself a dose. The pump must be running to start a dose.

### To start a dose:

1. Press  on the pump (or the button on the Remote Dose Cord). Two beeps will sound and this screen will appear:



The pump will begin delivering the dose. When the Main Screen is displayed, **DOSING** will appear.

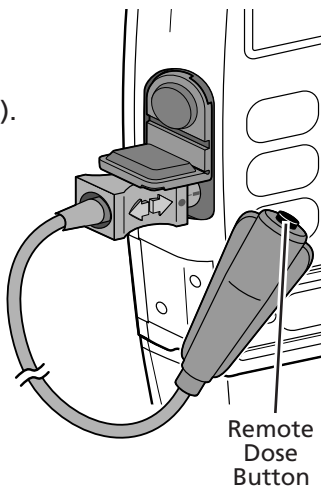

---

---

**WARNING: Do not place the Remote Dose Cord where the button might accidentally be pushed. Accidentally pushing the button may deliver a Dose, causing over-delivery of medication, which could result in death or serious injury.**

---

---



## Removing a Cassette

**WARNING:** Close the tubing clamp before removing the cassette from the pump to prevent unregulated infusion, which could result in death or serious injury.

To remove a cassette:

1. Press **STOP START** to stop the pump. When **Stop the pump?** appears, press **▲**.
2. Close all tubing clamps and disconnect the tubing from your access device as instructed by your clinician.
3. Insert the key and turn the lock clockwise one-quarter turn until it stops.
4. Unlatch the cassette by inserting the side of the key or a coin into the slot and turn clockwise until the latching button pops out.
5. Remove the cassette from the pump.
6. Discard the Medication Cassette™ Reservoir or CADD® Administration Set as instructed by your clinician.

Stop the Pump?  
Press Y or N

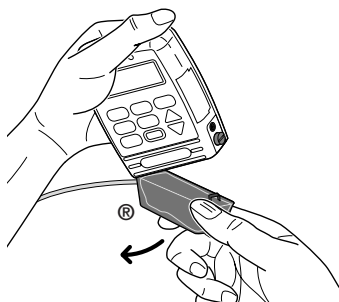
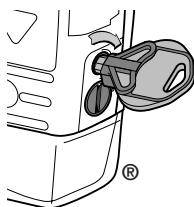

## Attaching a Cassette

---

---

### WARNING:

- You must use a CADD® Extension Set with Anti-Siphon Valve or a CADD® Administration Set with either an integral or add on Anti-Siphon Valve to protect against unregulated gravity infusion that can result from an improperly attached cassette. Unregulated gravity infusion can result in death or serious injury.
  - For detailed instructions and warnings pertaining to the Medication Cassette™ Reservoir or CADD® Administration Set, please refer to the instructions for use supplied with those products.
  - Frozen medication must be thawed at room temperature only. Do not heat the Medication Cassette™ Reservoir in a microwave oven as this may damage the medication, the Medication Cassette™ Reservoir, or cause leakage.
- 
- 

Use aseptic technique as instructed by your clinician.

1. Clamp the tubing on the new Medication Cassette™ Reservoir or CADD® Administration Set.
2. Insert the cassette hooks into the hinge pins on the pump.
3. Place the pump upright on a firm, flat surface. Press down so the cassette fits tightly against the pump.

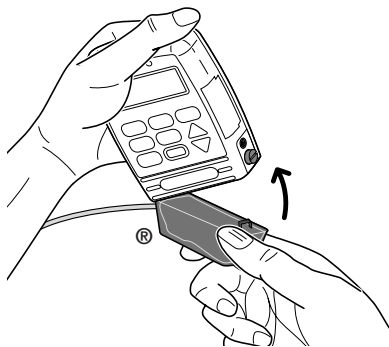

4. Insert the side of the key or a coin into the latching button, push in, and turn counterclockwise until the mark on the latch lines up with the solid dot.

A message will appear on the display showing the type of cassette you have latched.

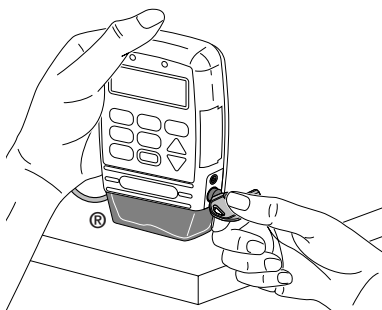

5. Insert the key into the lock and turn counterclockwise until the white mark lines up with the solid dot.

**NOTE:** The cassette must be latched and locked in order to start the pump.

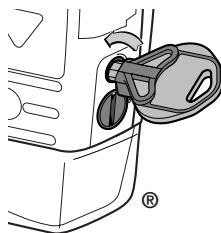

---

---

**WARNING:** Attach the cassette (the part of the Medication Cassette™ Reservoir or CADD® Administration Set that attaches to the pump) properly. An improperly attached or detached cassette could result in unregulated gravity infusion of medication from the fluid container or a reflux of blood, which could result in death or serious injury.

---

---

6. Gently twist and pull on the cassette to make sure it is firmly attached.

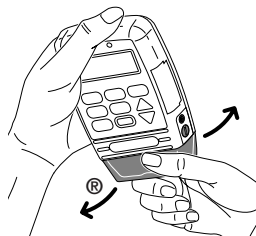

7. The message **Cassette Locked** will appear on the display. Press **NEXT**.

Cassette Locked

NEXT to continue

8. **Reset Reservoir Volume to** — ? may appear. Press **Y** to reset the Reservoir Volume to the originally programmed value.

Reset Reservoir  
Volume to 100.0 ml?

Press Y or N

## Resetting the Reservoir Volume

Normally, when you lock a new cassette on the pump, you will be prompted to reset the Reservoir Volume. You can, however, reset the Reservoir Volume without changing the cassette.

1. Begin at the Main Screen. Make sure **STOPPED** appears in the Main Screen.
2. Press **NEXT** to go to the Reservoir Volume screen.
3. Press **ENTER** to reset the Reservoir Volume to the originally programmed value.

## Priming the Tubing and Starting the Pump

When the new cassette is attached, the pump *may* automatically prompt you to prime the tubing.

1. If **Prime Tubing?** appears, press **Y**.
2. This screen will appear. Make sure you are not connected to the pump's tubing. Open the tubing clamps.

Prime Tubing?

Press Y or N

Disconnect tubing  
from patient  
Open clamps  
Hold Y to prime

---

---

**WARNING: Do not prime the fluid path with the tubing connected to your catheter. This could result in over-delivery of medication or air embolism, which could result in death or serious injury.**

---

---

3. Press and hold the **Y** key until the tubing is fully primed or until priming stops.
4. This screen will appear if you release the **Y** key or if priming automatically stops:
  - If the tubing is not yet fully primed, press the **Y** key and repeat step 3.
  - If you are finished priming, press the **N** key.

Priming...  
0.1 ml

Hold Y to prime

Continue Priming?

Press Y or N

When the new cassette is attached, the pump will automatically prompt you to start the pump.

5. When **Start the Pump?**

appears, check to see if the fluid path is free of air. If your clinician has instructed you to use the Air Detector, go to the next section. If not, follow your clinician's instructions for connecting the tubing to your access site. Open all clamps.

```
Start the Pump?  
  
Press Y or N
```

6. Press **▲** to start the pump.

**Starting pump...** will appear. The pump will automatically review and display the programmed settings.

```
Starting pump...
```

**RUNNING** will appear on the main screen, the green light will blink, and fluid delivery will begin as programmed by your clinician.

```
*** PCA 6210X ***  
RUNNING  
Res Vol 100.0 ml  
Press NEXT to advance
```

---

---

**WARNING: Ensure that the entire fluid path is free of all air bubbles before connecting to your catheter to prevent air embolism. Air embolism could result in death or serious injury.**

---

---

## Inserting the Tubing into the Air Detector

The Air Detector is designed to detect air bubbles in the fluid path. When the tubing is inserted into the Air Detector, an air bubble exceeding the specified size will cause an alarm to sound and the pump to stop.

1. If your clinician has instructed you to use the Air Detector, open the Air Detector door and thread the tubing through the groove.
2. Close the door, making sure the tubing does not get pinched or kinked.
3. Follow your clinician's instructions for connecting the tubing to your access site. Open all clamps.

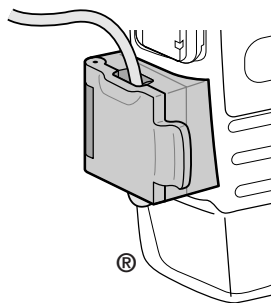
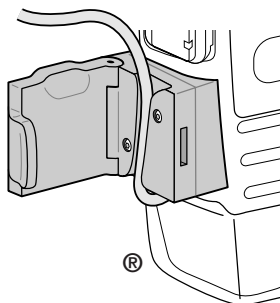

---

---

**WARNING: Ensure that the entire fluid path is free of all air bubbles before connecting to your catheter to prevent air embolism. Air embolism could result in death or serious injury.**

---

---



## Remote Dose Cord

When the Remote Dose Cord is attached you may deliver a dose by pressing either the Remote Dose Cord button, or the  Key. If you need to attach the Remote Dose Cord to the pump, follow the steps below.

---

---

**WARNING:** Do not place the Remote Dose Cord where the button might accidentally be pushed. Accidentally pushing the button may deliver a Dose, causing over-delivery of medication, which could result in death or serious injury.

---

---

**CAUTION:** Do not use the Remote Dose Cord to pick up or carry the pump. Using the cord in this manner could damage the pump or cord.

---

### To attach the Remote Dose Cord:

1. Open the cover over the Data In/Out jack.
2. Line up the red mark on the connector with the red mark on the pump.
3. Push the connector in until it clicks.

**NOTE:** Your connector may not look like the one pictured.

### To detach the Remote Dose Cord

1. Grasp the collar on the connector.
2. Pull the connector back using a straight, steady motion.  
DO NOT twist or turn the connector.

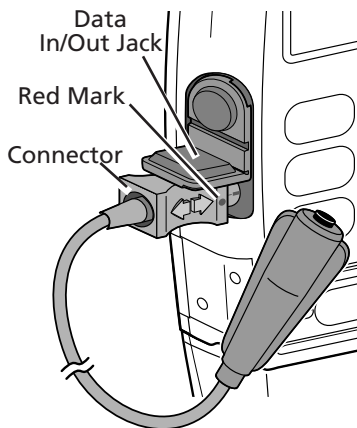

## What if I drop or hit the pump?

### What should I do if I drop the pump in water?

If you accidentally drop the pump in water, retrieve it quickly, dry it off with a towel, and call your clinician.

### What if I drop the pump or hit it against a hard surface?

Immediately do the following:

- Check the latch and lock on the side of the pump and make sure the dots on the latch and lock line up with the solid dots on the pump.
- Gently twist and pull on the cassette to make sure it is still firmly attached.
- Check the battery door to make sure it is still firmly attached.

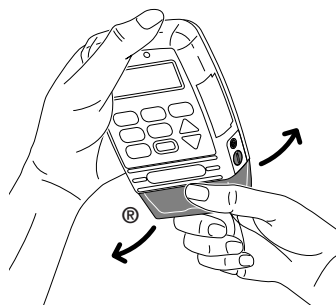
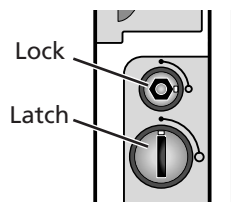

If the cassette or battery door are loose or damaged, do not use the pump. Immediately stop the pump, close the tubing clamp, and contact your clinician.

---

---

**WARNING: If the pump is dropped or hit, inspect the pump for damage. Do not use a pump that is damaged, or is not functioning properly. Depending on the type of damage, death or serious injury could result from the use of a damaged pump.**

---

---

## Alarms and Messages

If there are alarms or special messages you need to be aware of, the pump will beep or sound an alarm. Look at the screen and follow the steps in this table, or press **(?)** for help.

When you see:	Take this action:
9 volt Battery Low NEXT to continue	The 9 volt battery is low but the pump is operable. Change the 9 volt battery soon.
9 volt Battery Depleted Install good battery	Install a new 9 volt battery. The pump will not run with a depleted 9 volt battery. A good battery must be installed even when an external source of power is connected.
<i>(blank display or random characters)</i>	A two-tone alarm is sounding and the amber light stays on. The 9 volt battery is depleted. Install a new battery.
Cassette Damaged Free flow may occur Clamp Tubing NEXT to silence	The pump detects the cassette is damaged. Close the tubing clamp and inspect the cassette for damage. Replace it if necessary.

## Alarms and Messages

When you see:

Take this action:

---

Cassette unlocked

Pump will not run  
NEXT to silence

The cassette must be locked onto the pump before it can be started. If an alarm is sounding, press **NEXT** to silence the alarm. Lock the cassette, then start the pump.

Air in line detected

Pump will not run  
NEXT to silence

There is air in the tubing or the tubing is not threaded through the air detector. Press **NEXT** to stop the alarm. Then follow your clinician's instructions for priming.

Dose Not Delivered  
Dose Locked Out

NEXT to continue

You must wait until more time passes before you can receive another dose.

High Pressure

Pump Stopped

There may be a kink in the tubing or a clamp may be closed. Unkink the tubing or open the clamp and the pump will resume delivery. You may press **STOP START** to stop the pump and silence the alarm for 2 minutes. After you remove the cause of high pressure, start the pump if necessary. If the alarm continues, contact your clinician.

## Alarms and Messages



When you see:

Take this action:

---

Delivery Stopped



(Model 6101 only)

Fluid is not flowing from the fluid container to the pump. Check for a kink, a closed clamp, or an air bubble in the tubing between fluid container and pump. Press  to stop the pump and silence the alarm for 2 minutes, then remove the obstruction and press  to restart the pump.

Upstream Occlusion

Press STOP to silence

(Model 6101 only)

Fluid is not flowing from the fluid container to the pump. Check for a kink, a closed clamp, or an air bubble in the tubing between fluid container and pump. Press  to stop the pump and silence the alarm for 2 minutes, then remove the obstruction and press  to restart the pump.

## Alarms and Messages



When you see:

Take this action:

Upstream Occlusion

Press STOP to stop  
Press NEXT to restart

(Model 6101 only)

Fluid is not flowing from the fluid container to the pump. Check for a kink, a closed clamp, or an air bubble in the tubing between fluid container and pump. Press  to stop the pump and silence the alarm, then remove the obstruction and press  to restart the pump.

Reservoir Volume  
is zero

NEXT to continue

The Reservoir Volume has reached 0.0 ml. Press  to stop the alarm. Then install a new fluid container, if appropriate.

Reservoir Volume  
Low

NEXT to continue

The Reservoir Volume value is low, indicating that the level of fluid in the fluid container is low. Prepare to install a new fluid container.

Error Detected  
E (*error code*)

There is a problem with the pump. Close the tubing clamp and remove the pump from service. Contact your clinician.



## Your Clinician's

Name: \_\_\_\_\_

Phone Number: \_\_\_\_\_

### **Instructions:**

Pump placement during bathing/showering: \_\_\_\_\_

\_\_\_\_\_

Pump placement during sleep: \_\_\_\_\_

\_\_\_\_\_

Storage of medication: \_\_\_\_\_

\_\_\_\_\_



## Notes



## Deltec

SIMS Deltec, Inc., St. Paul, MN 55112 U.S.A.

**SIMS** SMITHS INDUSTRIES  
Medical Systems

CADD, CADD-Prizm, Medication Cassette and Medication Cassette Reservoir design are SIMS trademarks.

DURACELL® is a registered trademark of DURACELL INC. EVEREADY® ENERGIZER® is a registered trademark of Union Carbide Corporation. ULTRALIFE® is a registered trademark of ULTRALIFE Batteries, Inc.

These products are covered by one or more of the following: U.S. Patent Nos. 4,559,038; 4,565,542; 4,650,469; 5,181,910; 5,338,157; 5,364,242; 5,485,408; 5,531,697; 5,531,698; 5,538,399; 5,540,561; 5,564,915; 5,567,136; 5,567,119; 5,695,473 (Model 6101 only); other patents pending.

© 2000 SIMS Deltec, Inc.  
All rights reserved. Printed in U.S.A.

2000-04  
40-3744-01C